

Wall mounted receptacle - Part no. 101

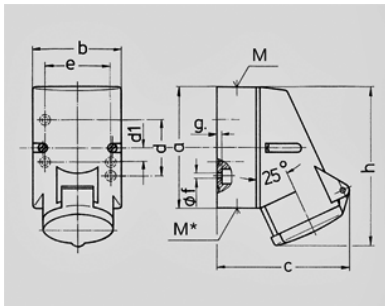

- screw terminals
- internal fixing
- one cable entry at top and one blind entry (can be cut out) at the bottom
- 4p and 5p receptacles the enclosure can be turned 180°

Technical information	
Ampere	16 A
Poles	3p
Voltage	230V
Earth position	6 h
Hertz	50-60 Hz
Connection technology	Screw terminals
Contact	standard
Protection type	IP 44



Drawing 1 MB 209	Amp. Poles	16		
		3	4	5
Dim. in mm	a	87	100	100
	b	64	75	75
	c	99	110	113
	d	40	-	-
	d1	-	11	11
	e	50	59	59
	f	4,5	5	5
	g	4	4	4
	h	115	125	128
	M	20	20	20
	M*	M20 (blind) to be cut out		
	Max. cable diam. (mm)	15	15	15
	Terminal for cond. cross section (mm ²) min.-max.	1,5	1,5	1,5
		-4	-4	-4